







WORKSTATION JPM LAMINATE

- Cubical Setting
- Irregular Top Table
- Laminated Panel
- 100cm Height Panel
- Light Grey Table Top
- Dark Grey Table Leg

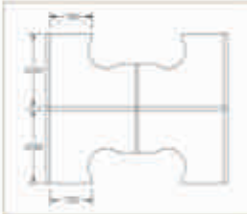

WORKSTATION JPM FABRIC

- Cubical Setting
- Irregular Top Table
- Counter Top Table
- Fabric Panel
- 100cm & 135cm Height Panel
- Cappuccino Table Top

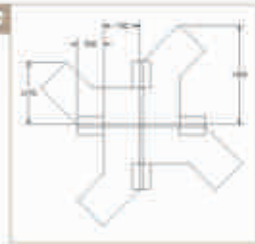

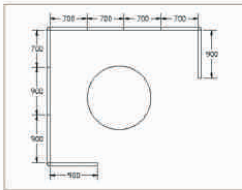

MEETING AREA JPM LAMINATE

- Laminate Panel
- Sunblasted Panel
- 180cm Panel Height

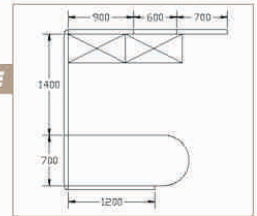

MANAGER ROOM JPM LAMINATE

- Laminate Panel
- Hanging Cabinet
- Regular Top Table
- Low Sliding Door Cabinets
- Combination of 100 cm half glass, 150cm and 180cm Panel Height

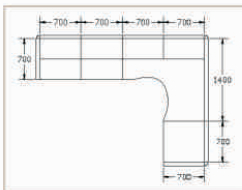

WORKSTATION JPM LAMINATE

- Laminate Panel
- Combination of 100cm, 150cm & 180cm Height Panel
- Hanging Tray with Metal Bracket
- Keyboard Tray
- Mobile Pedestal

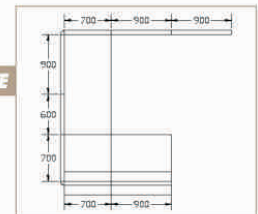

RECEPTIONIST JPM LAMINATE

- Laminate & Full Glass Panel
- Combination of 100 cm & 180cm Height Panel
- Regular Top Table
- Counter Top Table



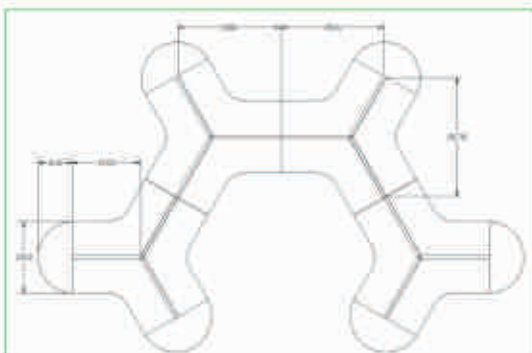

WORKSTATIONS SETTING

JPF FABRIC

- Irregular Top Table
- Half Glass & Fabric Panel
- Sand Blasted Glass
- 120cm Height Panel
- Light Grey Table Top
- Joining Top with Black Metal Leg
- Mobile Pedestal





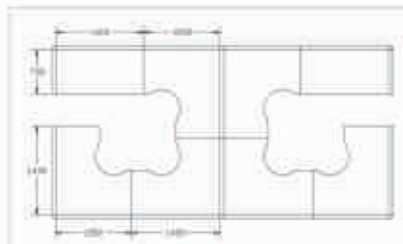

WORKSTATION *JPL LAMINATE*

- Laminate Panel
- Hanging Cabinet
- Irregular & Regular Top Table
- Combination of 100 cm half glass, and 180cm Panel Height

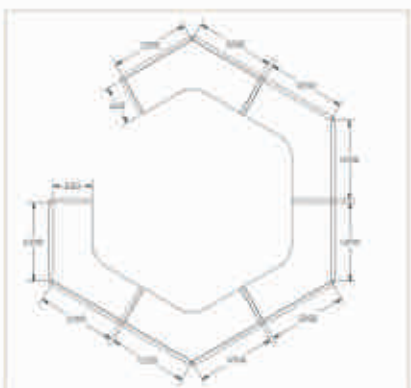

WORKSTATION *JPL FABRIC*

- Fabric Panel
- Irregular Top Table
- 100 cm half glass Panel Height





JPM CABLE MANAGEMENT

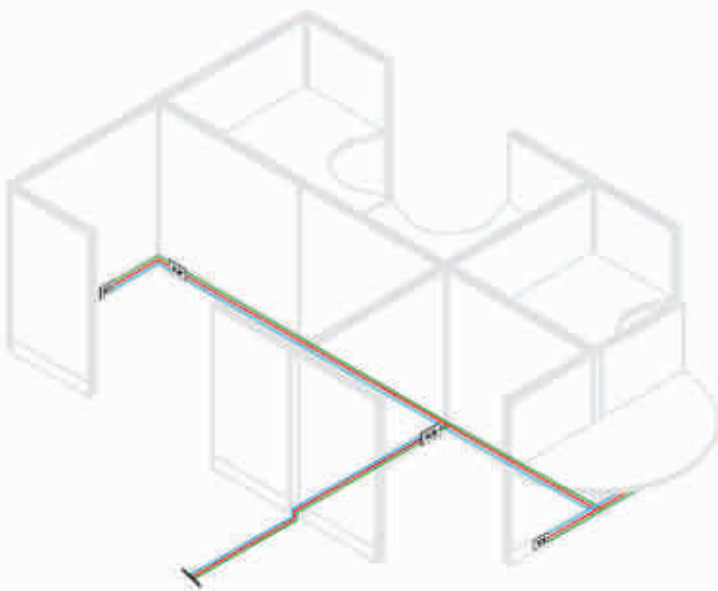

HORIZONTAL
CABLE MANAGEMENT
(ALL SERIES)



RACEWAY
(FOR JPF & JPL SERIES ONLY)

JPF & JPL CABLE MANAGEMENT

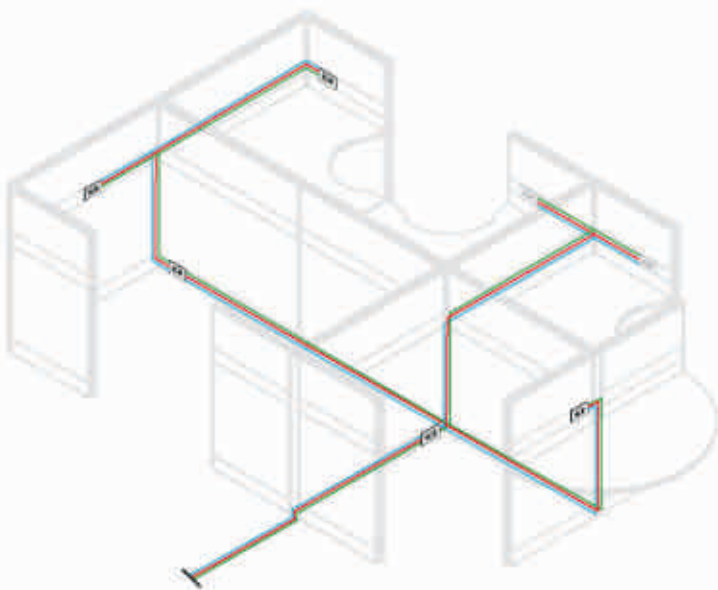

LIGHT GREY



OXFORD CHERRY



CAPPUCCINO

TOP TABLE MATERIAL SELECTIONS

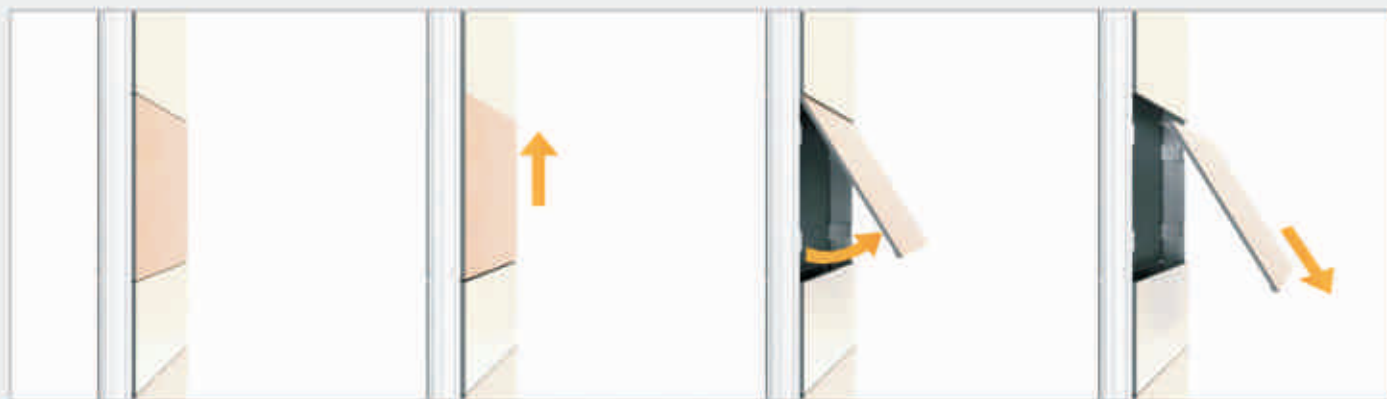
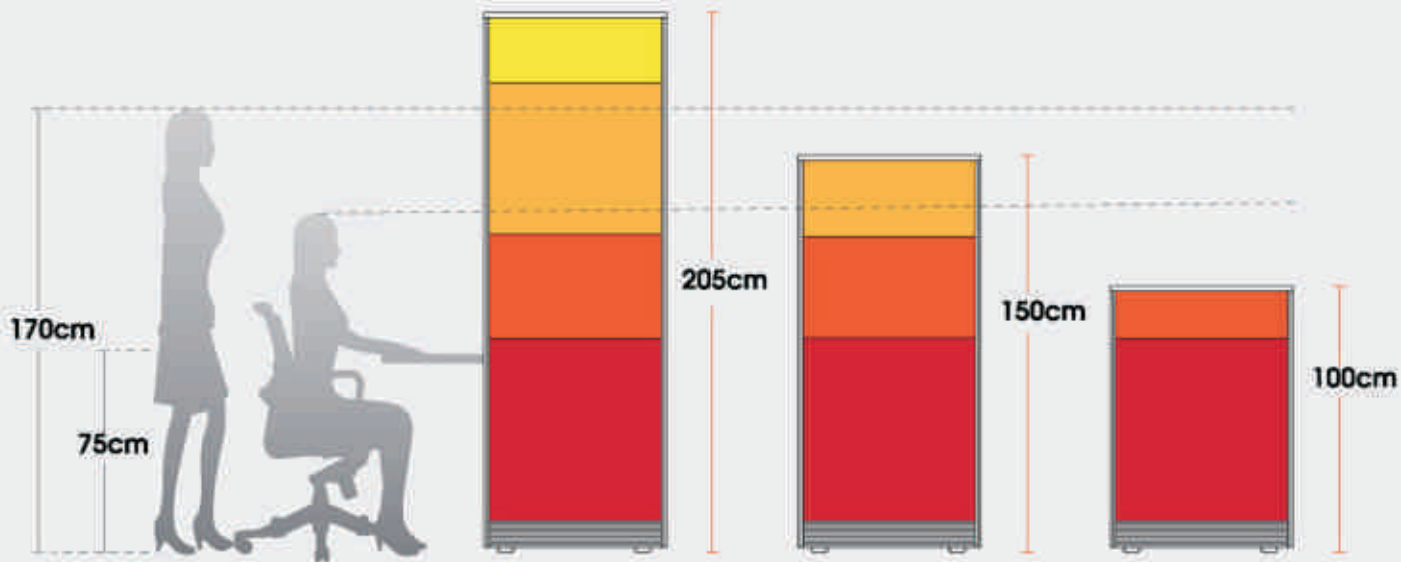

JPI TILING SYSTEM

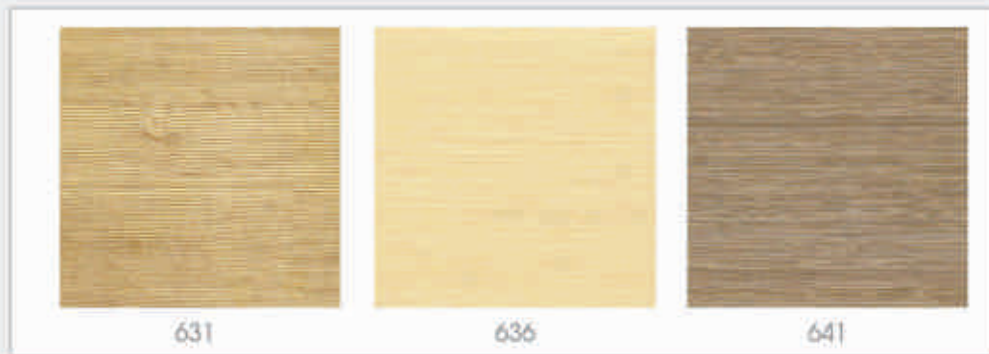











LAMINATE PANEL MATERIAL SELECTIONS





















NETWORK, TELEPHONE & ELECTRIC SOCKETS

JPM SERIES

Figure	Dimension (mm)		Fabric	Laminate
	H1/H2	W		
	1000 / -	500	FFM11050	LFM11050
		600	FFM11060	LFM11060
		700	FFM11070	LFM11070
		900	FFM11090	LFM11090
		1200	FFM11012	LFM11012
	1200 / -	500	FFM11250	LFM11250
		600	FFM11260	LFM11260
		700	FFM11270	LFM11270
		900	FFM11290	LFM11290
		1200	FFM11212	LFM11212
	1500 / -	500	FFM11550	LFM11550
		600	FFM11560	LFM11560
		700	FFM11570	LFM11570
		900	FFM11590	LFM11590
		1200	FFM11512	LFM11512
	1800 / -	500	FFM11850	LFM11850
		600	FFM11860	LFM11860
		700	FFM11870	LFM11870
		900	FFM11890	LFM11890
		1200	FFM11812	LFM11812
	2050 / -	500	FFM12050	LFM12050
		600	FFM12060	LFM12060
		700	FFM12070	LFM12070
		900	FFM12090	LFM12090
		1200	FFM12012	LFM12012
	1000/200	500	FHM11250	LHM11250
		600	FHM11260	LHM11260
		700	FHM11270	LHM11270
		900	FHM11290	LHM11290
		1200	FHM11212	LHM11212
	1000/500	500	FHM11550	LHM11550
		600	FHM11560	LHM11560
		700	FHM11570	LHM11570
		900	FHM11590	LHM11590
		1200	FHM11512	LHM11512
	1000/800	500	FHM11850	LHM11850
		600	FHM11860	LHM11860
		700	FHM11870	LHM11870
		900	FHM11890	LHM11890
		1200	FHM11812	LHM11812
	1000/1050	500	FHM12050	LHM12050
		600	FHM12060	LHM12060
		700	FHM12070	LHM12070
		900	FHM12090	LHM12090
		1200	FHM12012	LHM12012
	1000 / -	500	GFM11050	
		600	GFM11060	
		700	GFM11070	
		900	GFM11090	
		1200	GFM11012	
	1200 / -	500	GFM11250	
		600	GFM11260	
		700	GFM11270	
		900	GFM11290	
		1200	GFM11212	

JPF SERIES

Figure	Dimension (mm)		Fabric	Figure	Dimension (mm)		Fabric
	H1 / H2 / H3 / H4 / H5	W			H1 / H2 / H3 / H4 / H5	W	
	800 / 200 / - / - / -	500	FFF11050		800 / 100 / 300 / 600 / 250	500	FFF22050
		600	FFF11060			600	FFF22060
		700	FFF11070			700	FFF22070
		900	FFF11090			900	FFF22090
		1200	FFF11012			1200	FFF22012
	800 / 400 / - / - / -	500	FFF11250		800 / 100 / 300 / 600 / 250	500	FFF22050
		600	FFF11260			600	FFF22060
		700	FFF11270			700	FFF22070
		900	FFF11290			900	FFF22090
		1200	FFF11212			1200	FFF22012
	800 / 400 / 300 / - / -	500	FFF11550		800 / 100 / 300 / 600 / 250	500	FFF22050
		600	FFF11560			600	FFF22060
		700	FFF11570			700	FFF22070
		900	FFF11590			900	FFF22090
		1200	FFF11512			1200	FFF22012
	800 / 400 / 600 / - / -	500	FFF11850		800 / 100 / 300 / 600 / 250	500	FFF22050
		600	FFF11860			600	FFF22060
		700	FFF11870			700	FFF22070
		900	FFF11890			900	FFF22090
		1200	FFF11812			1200	FFF22012
	800 / 400 / 600 / 250 / -	500	FFF12050		800 / 100 / 300 / 600 / 250	500	FFF22050
		600	FFF12060			600	FFF22060
		700	FFF12070			700	FFF22070
		900	FFF12090			900	FFF22090
		1200	FFF12012			1200	FFF22012
	800 / 100 / 100 / - / -	500	FFF21050		800 / 100 / 300 / 600 / 250	500	FFF22050
		600	FFF21060			600	FFF22060
		700	FFF21070			700	FFF22070
		900	FFF21090			900	FFF22090
		1200	FFF21012			1200	FFF22012
	800 / 100 / 300 / - / -	500	FFF21250		800 / 100 / 300 / 600 / 250	500	FFF22050
		600	FFF21260			600	FFF22060
		700	FFF21270			700	FFF22070
		900	FFF21290			900	FFF22090
		1200	FFF21212			1200	FFF22012
	800 / 100 / 300 / 300 / -	500	FFF21550		800 / 100 / 300 / 600 / 250	500	FFF22050
		600	FFF21560			600	FFF22060
		700	FFF21570			700	FFF22070
		900	FFF21590			900	FFF22090
		1200	FFF21512			1200	FFF22012
	800 / 100 / 300 / 600 / -	500	FFF21850		800 / 100 / 300 / 600 / 250	500	FFF22050
		600	FFF21860			600	FFF22060
		700	FFF21870			700	FFF22070
		900	FFF21890			900	FFF22090
		1200	FFF21812			1200	FFF22012

JPF SERIES

Figure	Dimension (mm)		Fabric
	H1 / H2 / H3 / H4 / H5	W	
	800 / 200 / 400 / 100 / -	500	FFF31560
		600	FFF31560
		700	FFF31570
		900	FFF31590
		1200	FFF31512
	800 / 200 / 400 / 400 / -	500	FFF31850
		600	FFF31860
		700	FFF31870
		900	FFF31890
		1200	FFF31812
	800 / 200 / 400 / 650 / -	500	FFF32050
		600	FFF32060
		700	FFF32070
		900	FFF32090
		1200	FFF32012
	800 / 100 / 100 / 400 / 100	500	FFF41530
		600	FFF41560
		700	FFF41570
		900	FFF41590
	800 / 100 / 100 / 400 / 400	1200	FFF41512
		1400	FFF41514
		500	FFF41850
		600	FFF41860
	800 / 100 / 100 / 400 / 400	700	FFF41870
		900	FFF41890
		1200	FFF41812
		800 / 100 / 100 / 400 / 650	500
600	FFF42060		
700	FFF42070		
900	FFF42090		
1200	FFF42012		
	800 / 400 / - / - / -	500	GFF11250
		600	GFF11260
		700	GFF11270
		900	GFF11290
		1200	GFF11212
	800 / 400 / 300 / - / -	1400	GFF11214
		500	GFF11550
		600	GFF11560
		700	GFF11570
		900	GFF11590
	800 / 400 / 600 / - / -	1200	GFF11512
		1400	GFF11514
		500	GFF11850
		600	GFF11860
		700	GFF11870
900	GFF11890		
1200	GFF11812		
	800 / 400 / 850 / - / -	500	GFF12050
		600	GFF12060
		700	GFF12070
		900	GFF12090
		1200	GFF12012

JPL SERIES

Figure	Dimension (mm)		Fabric	Laminate	Figure	Dimension (mm)		Fabric
	H1 / H2 / H3 / H4 / H5	W				H1 / H2 / H3 / H4 / H5	W	
	800 / 200 / - / - / -	500	FFL11050	LFL11050		800 / 200 / - / - / -	500	GFL11050
		600	FFL11060	LFL11060			600	GFL11060
		700	FFL11070	LFL11070			700	GFL11070
		900	FFL11090	LFL11090			900	GFL11090
		1200	FFL11012	LFL11012			1200	GFL11012
1400	FFL11014	LFL11014	1400	GFL11014				
	800 / 200 / 200 / - / -	500	FFL11250	LFL11250		800 / 200 / 200 / - / -	500	GFL11250
		600	FFL11260	LFL11260			600	GFL11260
		700	FFL11270	LFL11270			700	GFL11270
		900	FFL11290	LFL11290			900	GFL11290
		1200	FFL11212	LFL11212			1200	GFL11212
1400	FFL11214	LFL11214	1400	GFL11214				
	800 / 200 / 500 / - / -	500	FFL11550	LFL11550		800 / 200 / 500 / - / -	500	GFL11550
		600	FFL11560	LFL11560			600	GFL11560
		700	FFL11570	LFL11570			700	GFL11570
		900	FFL11590	LFL11590			900	GFL11590
		1200	FFL11512	LFL11512			1200	GFL11512
1400	FFL11514	LFL11514	1400	GFL11514				
	800 / 200 / 500 / 300 / -	500	FFL11850	LFL11850		800 / 200 / 800 / - / -	500	GFL11850
		600	FFL11860	LFL11860			600	GFL11860
		700	FFL11870	LFL11870			700	GFL11870
		900	FFL11890	LFL11890			900	GFL11890
		1200	FFL11812	LFL11812			1200	GFL11812
	800 / 200 / 500 / 550 / -	500	FFL12050	LFL12050		800 / 200 / 1050 / - / -	500	GFL12050
		600	FFL12060	LFL12060			600	GFL12060
		700	FFL12070	LFL12070			700	GFL12070
		900	FFL12090	LFL12090			900	GFL12090
		1200	FFL12012	LFL12012			1200	GFL12012
	800 / 200 / 200 / - / -	500	FHL11250	LHL11250		800 / 200 / 500 / - / -	500	GFL12050
		600	FHL11260	LHL11260			600	GFL12060
		700	FHL11270	LHL11270			700	GFL12070
		900	FHL11290	LHL11290			900	GFL12090
		1200	FHL11212	LHL11212			1200	GFL12012
1400	FHL11214	LHL11214	1400	GFL12012				
	800 / 200 / 500 / - / -	500	FHL11550	LHL11550		800 / 200 / 500 / - / -	500	GFL11550
		600	FHL11560	LHL11560			600	GFL11560
		700	FHL11570	LHL11570			700	GFL11570
		900	FHL11590	LHL11590			900	GFL11590
		1200	FHL11512	LHL11512			1200	GFL11512
1400	FHL11514	LHL11514	1400	GFL11514				
	800 / 200 / 800 / - / -	500	FHL11850	LHL11850		800 / 200 / 800 / - / -	500	GFL11850
		600	FHL11860	LHL11860			600	GFL11860
		700	FHL11870	LHL11870			700	GFL11870
		900	FHL11890	LHL11890			900	GFL11890
		1200	FHL11812	LHL11812			1200	GFL11812
	800 / 200 / 1050 / - / -	500	FHL12050	LHL12050		800 / 200 / 1050 / - / -	500	GFL12050
		600	FHL12060	LHL12060			600	GFL12060
		700	FHL12070	LHL12070			700	GFL12070
		900	FHL12090	LHL12090			900	GFL12090
		1200	FHL12012	LHL12012			1200	GFL12012



Figure	Dimension (mm)		Grey	Oxford Cherry	Cappuccino
	L	W			
	480	600	TRG16045	TRO16045	TRN16045
		700	TRG17045	TRO17045	TRN17045
		900	TRG19045	TRO19045	TRN19045
		1000	TRG11045	TRO11045	TRN11045
		1200	TRG11245	TRO11245	TRN11245
		1400	TRG11445	TRO11445	TRN11445
	500	1500	TRG11545	TRO11545	TRN11545
		1600	TRG11645	TRO11645	TRN11645
		1800	TRG11845	TRO11845	TRN11845
		900	TRG16050	TRO16050	TRN16050
		1000	TRG17050	TRO17050	TRN17050
		1200	TRG19050	TRO19050	TRN19050
600	1000	TRG11050	TRO11050	TRN11050	
	1200	TRG11250	TRO11250	TRN11250	
	1400	TRG11450	TRO11450	TRN11450	
	800	TRG16060	TRO16060	TRN16060	
	900	TRG17060	TRO17060	TRN17060	
	1000	TRG19060	TRO19060	TRN19060	
700	1000	TRG11060	TRO11060	TRN11060	
	1200	TRG11260	TRO11260	TRN11260	
	1400	TRG11460	TRO11460	TRN11460	
	900	TRG17070	TRO17070	TRN17070	
	1000	TRG19070	TRO19070	TRN19070	
	1200	TRG11070	TRO11070	TRN11070	
	480	1050	TCG11045	TCO11045	TCN11045
		1150	TCG11145	TCO11145	TCN11145
		1250	TCG11245	TCO11245	TCN11245
		1350	TCG11345	TCO11345	TCN11345
		1450	TCG11445	TCO11445	TCN11445
		1650	TCG11645	TCO11645	TCN11645
	500	1800	TCG11845	TCO11845	TCN11845
		1950	TCG11945	TCO11945	TCN11945
		2050	TCG12045	TCO12045	TCN12045
		2250	TCG12245	TCO12245	TCN12245
		1200	TUG11260	TUO11260	TUN11260
		1400	TUG11460	TUO11460	TUN11460
700	1500	TUG11560	TUO11560	TUN11560	
	1600	TUG11660	TUO11660	TUN11660	
	1800	TUG11860	TUO11860	TUN11860	
	1200	TUG11270	TUO11270	TUN11270	
	1400	TUG11470	TUO11470	TUN11470	
	1600	TUG11670	TUO11670	TUN11670	
1800	TUG11870	TUO11870	TUN11870		



Figure	Dimension (mm)		Grey	Oxford Cherry	Cappuccino
	L1/L2	W1/W2			
	1200/1400	700/500	TLG12475	TLO12475	TUN12475
		700/600	TLG12476	TLO12476	TUN12476
		700/700	TLG12477	TLO12477	TUN12477
	1200/1800	600/600	TLG12556	TLO12556	TUN12556
		600/700	TLG12557	TLO12557	TUN12557
		600/800	TLG12558	TLO12558	TUN12558
	1200/1600	700/600	TLG12576	TLO12576	TUN12576
		700/700	TLG12577	TLO12577	TUN12577
		700/800	TLG12578	TLO12578	TUN12578
	1400/1400	500/700	TLG12657	TLO12657	TUN12657
		600/700	TLG12667	TLO12667	TUN12667
		700/700	TLG12677	TLO12677	TUN12677
500/500		TLG14455	TLO14455	TUN14455	
600/600		TLG14456	TLO14456	TUN14456	
600/700		TLG14457	TLO14457	TUN14457	
1400/1600	600/500	TLG14465	TLO14465	TUN14465	
	600/600	TLG14466	TLO14466	TUN14466	
	600/700	TLG14467	TLO14467	TUN14467	
	700/500	TLG14475	TLO14475	TUN14475	
	700/600	TLG14476	TLO14476	TUN14476	
	700/700	TLG14477	TLO14477	TUN14477	
1400/1800	500/600	TLG14555	TLO14555	TUN14555	
	600/700	TLG14557	TLO14557	TUN14557	
	600/600	TLG14566	TLO14566	TUN14566	
	600/700	TLG14567	TLO14567	TUN14567	
	700/600	TLG14576	TLO14576	TUN14576	
	700/700	TLG14577	TLO14577	TUN14577	
1400/1600	900/700	TLG14667	TLO14667	TUN14667	
	600/700	TLG14677	TLO14677	TUN14677	
	700/700	TLG14677	TLO14677	TUN14677	
1500/1500	600/600	TLG15566	TLO15566	TUN15566	
	600/700	TLG15567	TLO15567	TUN15567	
	700/600	TLG15576	TLO15576	TUN15576	
1600/1600	700/700	TLG15577	TLO15577	TUN15577	
	700/700	TLG16677	TLO16677	TUN16677	
	700/700	TLG16677	TLO16677	TUN16677	
	1200/1200	600/600	TYG12256	TYO12256	TYN12256
	1200/1300	700/700	TYG12277	TYO12277	TYN12277
	1400/1400	600/600	TYG14466	TYO14466	TYN14466
	1400/1400	700/700	TYG14477	TYO14477	TYN14477

Figure	Dimension (mm)		Grey	Oxford Cherry	Cappuccino
	L1/L2	W1/W2			
	1200/1200	500/500	TLG12256	TLO12256	TUN12256
		500/600	TLG12256	TLO12256	TUN12256
		500/700	TLG12257	TLO12257	TUN12257
		600/500	TLG12265	TLO12265	TUN12265
		600/600	TLG12266	TLO12266	TUN12266
		600/700	TLG12267	TLO12267	TUN12267
	1200/1400	700/500	TLG12275	TLO12275	TUN12275
		700/600	TLG12276	TLO12276	TUN12276
		700/700	TLG12277	TLO12277	TUN12277
		900/500	TLG12455	TLO12455	TUN12455
		900/600	TLG12456	TLO12456	TUN12456
		900/700	TLG12457	TLO12457	TUN12457
1200/1400	600/500	TLG12465	TLO12465	TUN12465	
	600/600	TLG12466	TLO12466	TUN12466	
	600/700	TLG12467	TLO12467	TUN12467	









Figure	Dimension (mm)			Grey	Oxford Cherry	Cappuccino
	W	D	H			
 HANGING TRAY	500 600 700 900	350	180	HGG15035 HTG16035 HTG17035 HTG19035	HTO15035 HTO16035 HTO17035 HTO19035	HTN15035 HTN16035 HTN17035 HTN19035
 HANGING ROLLER SHUTTER	500 600 700 900	400	510	HRG15040 HRG16040 HRG17040 HRG19040	HRO15040 HRO16040 HRO17040 HRO19040	HRN15040 HRN16040 HRN17040 HRN19040
 HANGING CABINET	500 600 700 900	400	510	HCG15040 HCG16040 HCG17040 HCG19040	HCO15040 HCO16040 HCO17040 HCO19040	HCN15040 HCN16040 HCN17040 HCN19040
 MOBILE PEDESTAL	400	500	560	MBG14050	MBO14050	MBN14050
 MOBILE PEDESTAL	400	500	560	MBG14060	MBO14060	MBN14060
 MOBILE PEDESTAL	400	500	720	MBG14070	MBO14070	MBN14070
 LOW OPEN SHELF CABINET	700	400	750	SOG17975	SOO17975	SON17975
 HIGH OPEN SHELF CABINET	700	400	1200	SOG17912	SOO17912	SON17912
 LOW SLIDING DOOR CABINET	700	400	750	SLG17975	SLO17975	SUN17975









Figure	Dimension (mm)			Grey	Oxford Cherry	Cappuccino
	W	D	H			
 HIGH SLIDING DOOR CABINET	790	400	1200	SLG17912	SLO17912	SUN17912
 TABLE LEG	18	400 500 600	730	KKY11840 KKY11860 KKY11860 (DARK GREY)		
 KEYBOARD TRAY	550	400	80	KVB (BLACK)		
 METAL LEG		DIA 8	72	KU-UT (BLACK)		

Figure	Dimension (mm)			Grey	Oxford Cherry	Cappuccino
	W	D	H			
 PVC DOOR	900	45	2000	DVW12090 (PVC WHITE)		
 FULL PANEL DOOR	900	45	2000	DLG12090	DLO12090	DUN12090
 HALF GLASS DOOR	900	45	2000	DHG12090	DHO12090	DHN12090
 FULL GLASS DOOR	900	45	2000	DGG12090	DGO12090	DGN12090

