

PRIVACY ANYTIME, ANYWHERE



WHY HiPOD?



HIGH QUALITY PERFORMANCE

User friendly to work and study in a well ventilated space with adjustable light and acoustic properties TUV -32 dB/NIC



SMART ENERGY EFFICIENCY

Featuring automatic thermal sensor to ensure efficient electric consumption



EASY TO ASSEMBLE

Fully Knock Down and designed for easy assembly with illustrative instruction



FINEST MATERIAL STANDARD

Automated production processes ensure consistency and accuracy along with premium galvanised material.

WHY HIPOD?



HIGH ACOUSTIC RATING
TUV - 32 dB / NIC
 CERTIFIED BY TUV



VOC AND FORMALDEHYDE-RATING
0.005 MG/M3
 CERTIFIED BY SGS



Ventilation Access



Working Table



LED Strip Light



Motion Sensor



Wireless Dimmer



Safety Glass & Dorma Locksets



AH Meyer Power & USB Charging

EXTERIOR COLOUR



SMOKE WHITE



CHARCOAL BLACK



SILVER



SPACE GREY



SKY BLUE



LAGOON BLUE



ROSE PINK



DANDELION YELLOW

ACOUSTIC SHEET COLOUR SELECTION

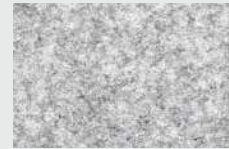

LIGHT GREY



CHARCOAL BLACK

CARPET COLOUR SELECTION

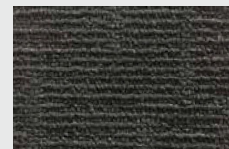

BLACK



SILVER (MEET Only)

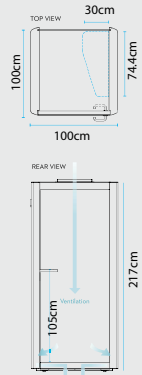

SINGLE

Capacity : (exclude stool)

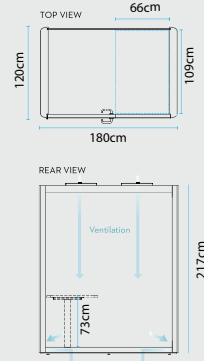

PRIVATE

Capacity : (exclude chair)

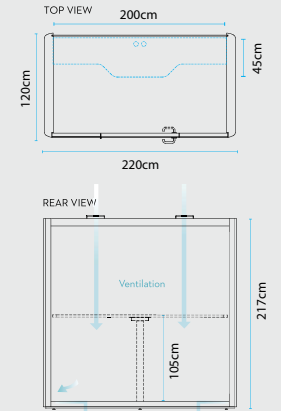

CHAT

Capacity : (exclude stools)

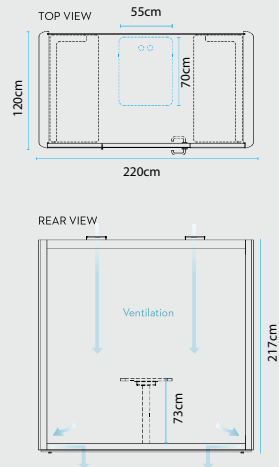

DUAL

Capacity : (include sofas)

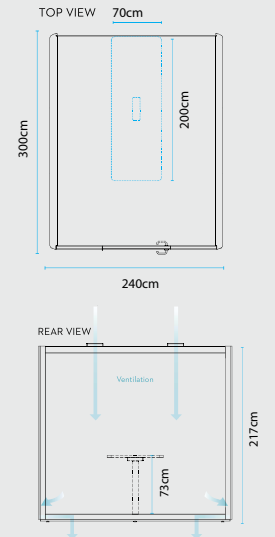

MEET

Capacity : (exclude chairs)

SUITABLE FOR

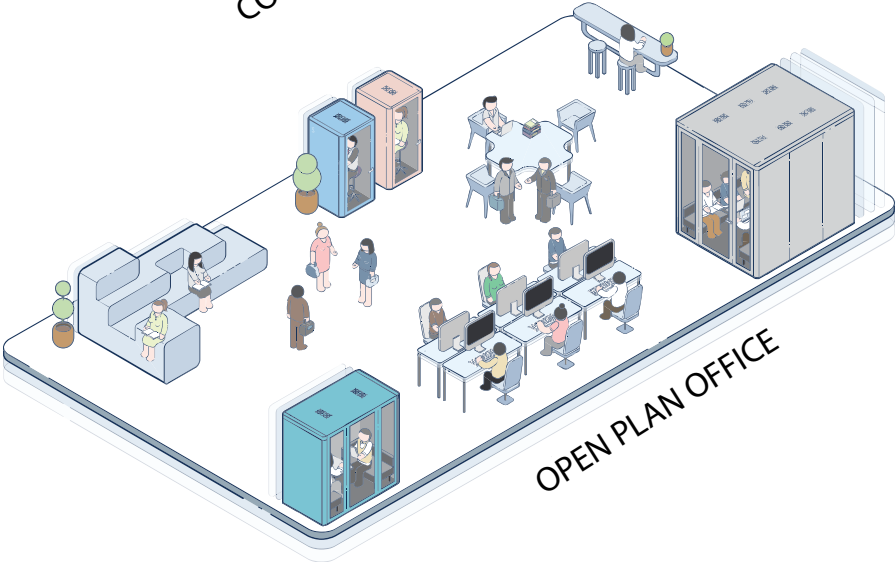
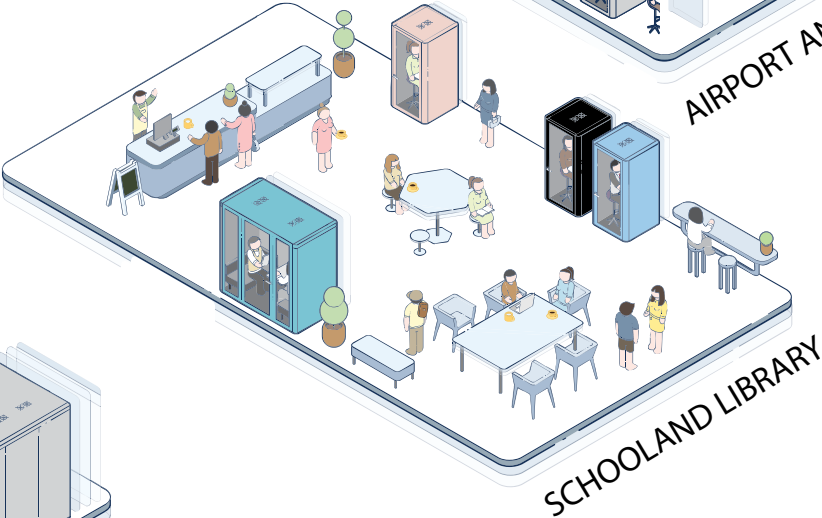
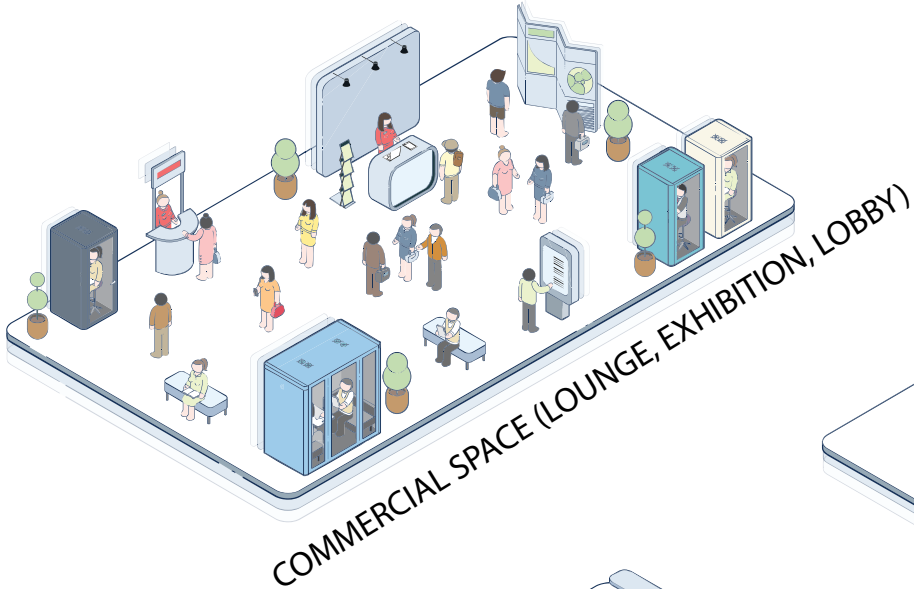



HiPOD | PRIVACY
ANYTIME, ANYWHERE

SPECIFICATION DETAILS

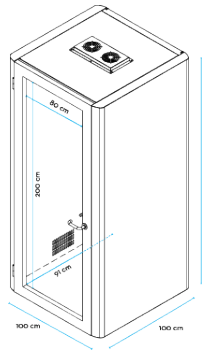

SINGLE

1NO X 11w LED strip with wireless dimmer
 2NOS X dual speed bearing fan (1 set)
 1NO X power socket AH Meyer Universal 110/240Vac
 1NO twin USB charger AH Meyer 110/240Vac
 1 NO X data CAT6
 hanging table dimension mm 300(D) X 744(W) X 25(T) x 1050(H)
 weight 320 kg
 stool excluded

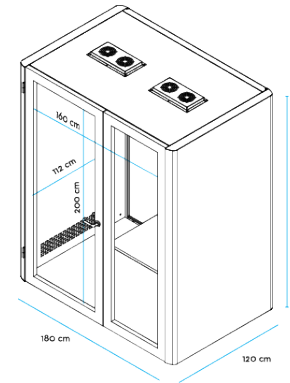

PRIVATE

2NOS X 11w LED strip with wireless dimmer
 4NOS X dual speed bearing fan
 2NOS X power socket AH Meyer Universal 110/240Vac
 1NO twin USB charger AH Meyer 110/240Vac
 1 NO X data CAT6
 table dimension mm 660(D) X 1090(W) X 25(T) x 750(H)
 weight 430 kg
 chair excluded

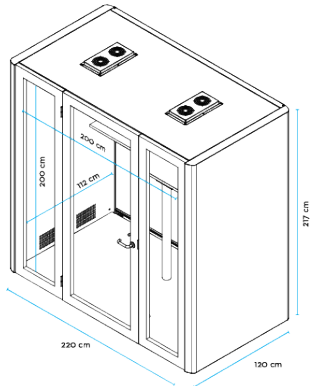

CHAT

1NO X 11w LED strip with wireless dimmer
 4NOS X dual speed bearing fan (2 set)
 1NO X power socket AH Meyer Universal 110/240Vac
 1NO twin USB charger AH Meyer 110/240Vac
 1 NO X data CAT6
 hanging table dimension mm 450(D) X 2000(W) X 25(T) x 1050(H)
 weight 650 kg
 stool excluded

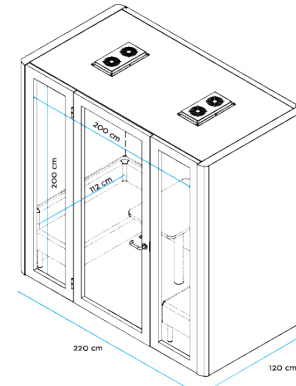

DUAL

1NO X 11w LED strip with wireless dimmer
 4NOS X dual speed bearing fan (2 set)
 1NO X power socket AH Meyer Universal 110/240Vac
 1NO twin USB charger AH Meyer 110/240Vac
 1 NO X data CAT6
 hanging table dimension mm 550(D) X 700(W) X 25(T) x 750(H)
 weight 650 kg
 sofas excluded

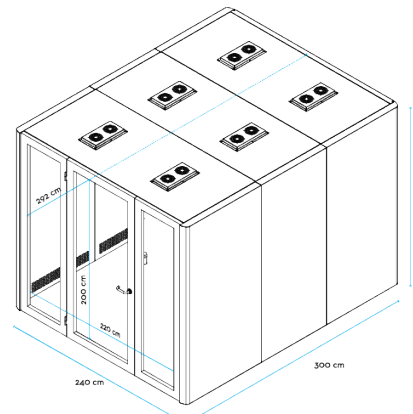

MEET

2NOS X 4000K LED strip with wireless dimmer
 12NOS X dual speed bearing fan
 2NO X power socket AH Meyer Universal 110/240Vac
 1NO twin USB charger AH Meyer 110/240Vac
 2NOS X data CAT6
 hanging table dimension mm 700(D) X 2000(W) X 25(T) x 750(H)
 weight 1300 kg
 chair excluded



 (021) 54361118

 highpointoffice.com

 [highpoint_office](https://www.instagram.com/highpoint_office)